

MYZEK®

Aluminum ceramic heater

INSTRUCTION MANUAL

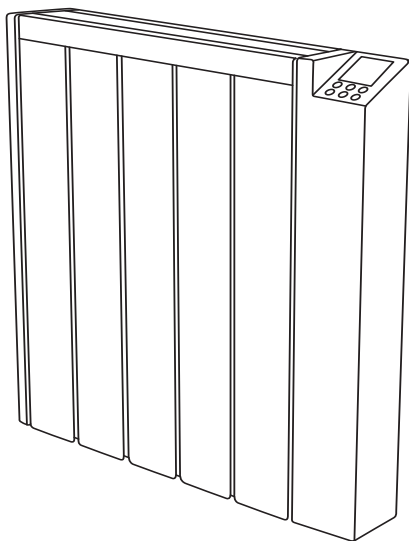

Model: MYHH0406C & MYHH0410C & MYHH0415C & MYHH0420C

BEFORE USE:

Please read the instructions carefully. You must inspect the appliance including its cable and plug for any signs of damage. If the product is damaged, **DO NOT USE** and contact your supplier immediately for refund or replacement.

This product is only suitable for well insulated spaces or occasional use.

Introduction:

General Information:

Please read the entire instruction manual before using the product and then save it for future reference. We reserve the right for any errors in text or images and any necessary changes made to technical data. If you have any questions concerning technical problems or programming of this unit please contact our dedicated Customer Services on 0800 091 3171 or email: sales@hygienesuppliesdirect.com who will only be too happy to help.

Please note for the first few uses of your Aluminium Heater a slight newness odour may occur due to all new components, this will disappear after the first few operations.



Safety Instructions:

Please read this instruction manual carefully before use and keep in a safe place for future reference. If you give the appliance to another person, supply them with this instruction manual.

- This appliance can be used by children aged from 8 years and above and persons with reduced physical, sensory or mental capabilities or lack of experience and knowledge, if they have been given supervision or instruction concerning use of the appliance in a safe way and understand the hazards involved. Children shall not play with the appliance. Cleaning and user maintenance shall not be made by children without supervision.

- Children of less than 3 years should be kept away unless continuously supervised.
- Children aged from 3 years and less than 8 years shall only switch on/off the appliance provided that it has been placed or installed in its intended, normal operating position and that they have been given supervision or instruction concerning use of the appliance in a safe way and understand the hazards involved. Children aged from 3 years and less than 8 years shall not plug in, regulate and clean the appliance or perform user maintenance.
- CAUTION - Some parts of this product can become very hot and cause burns. Particular attention has to be given where children and vulnerable people are present.
- If the supply cord is damaged, it must be replaced by the manufacturer, its service agent or a similarly qualified person in order to avoid a hazard.
- CAUTION: In order to avoid a hazard, due to inadvertent resetting of the thermal cutout, this appliance must not be supplied through an external switching device such as a timer, or connected to a circuit that is regularly switched on and off by the utility.
- The heater must not be located immediately below a socket-outlet.
- Means for disconnection having a contact separation in all poles must be incorporated in the fixed wiring in accordance with the wiring rules.
- For correct installation on the wall, please refer to 'Installation on wall' part of this manual.

- Fixed heaters are to be installed so that switches and other controls cannot be touched by a person in the bath or shower.



- **WARNING:** In order to avoid overheating, do not cover the heater.

Warning: When installed in a bathroom this product should be installed in volume 2 according to the national wiring rules and installed by a qualified electrician.

Note: The drawing on the next page is for reference and a guide only.

If installed in a bathroom, this unit must be installed by a qualified electrician.

In the case of outbuildings, a room with a bath or a shower installed and socket-outlets lower or equal to 32 A the circuit corresponding must be protected by a device with differential residual current (RCD) lower or equal to 30 mA.

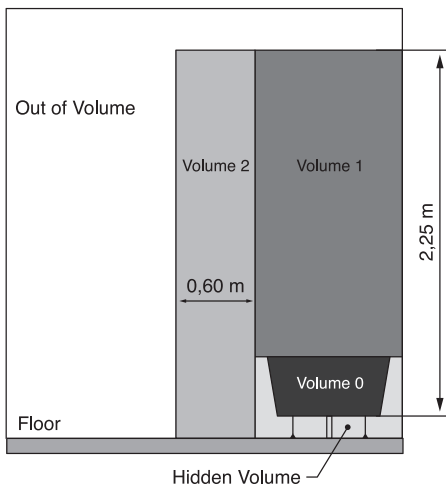

MODEL SPECIFICATIONS

Model No.	FINS	RATED VOLTAGE	RATED POWER
MYHH0406C	3	AC220-240V, 50-60Hz	600W
MYHH0410C	4	AC220-240V, 50-60Hz	1000W
MYHH0415C	5	AC220-240V, 50-60Hz	1500W
MYHH0420C	7	AC220-240V, 50-60Hz	2000W

STRUCTURE AND PARTS

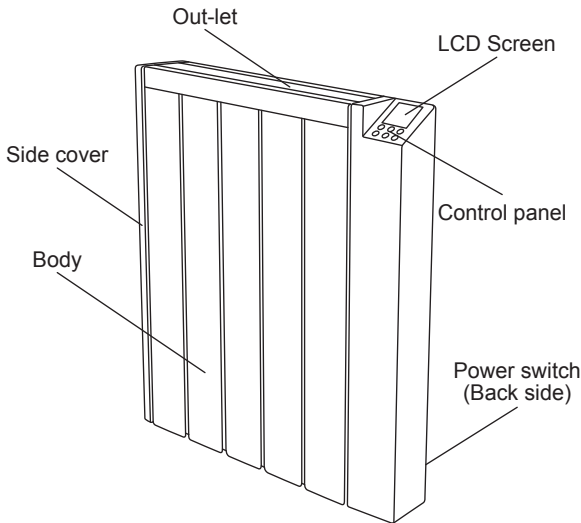

Installation / Wall Mounting

Picture one

Picture 2

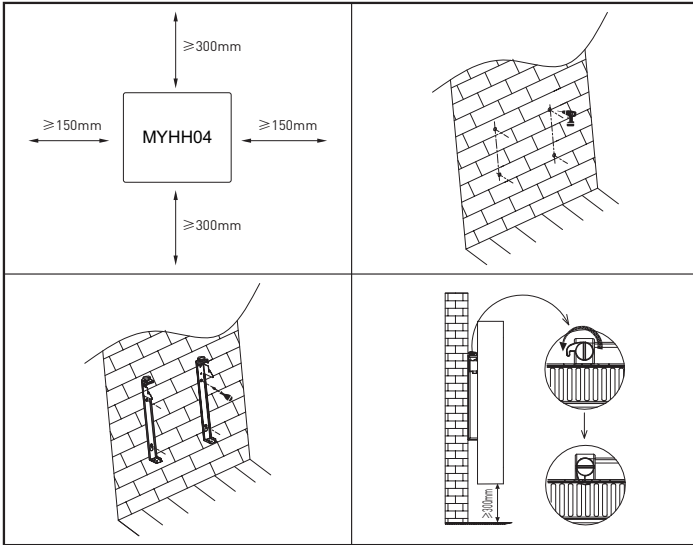

Picture 3

Picture 4

- 1) Drill holes on the wall according to the instructions below using a 10mm drill bit, please make sure you drill the correct measurements to your model number shown below.

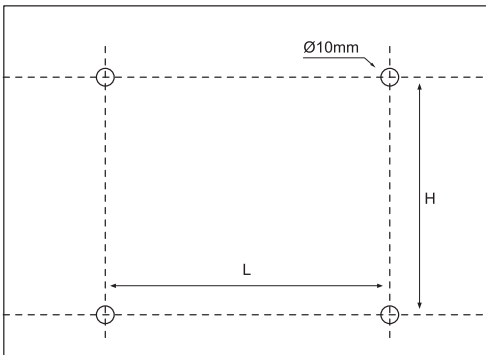

Model	H	L
MYHH0406C	240	200
MYHH0410C	240	300
MYHH0415C	240	400
MYHH0420C	240	600

- 2) Place the wall plugs tube into the drilled holes and secure the bracket to the wall with the screws provided. (Picture 3).
- 3) Hang the unit on the bracket gently, after ensuring the unit is secure, and then turn the lock in the bracket as the picture shows. (Picture 4).

Warning: Before using the heater, make sure it's mounted securely on the wall.

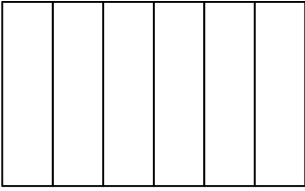

If not wall-mounting, please assemble the feet to the heater as shown above.

1) Control panel and screen.

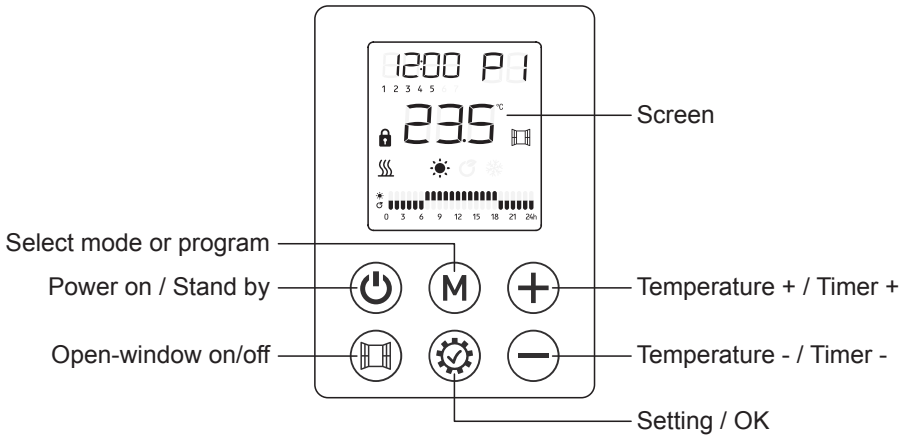

Buttons Explained:



Power on / stand by



Increasing Temperature and Timer setting.



Decreasing Temperature and Timer setting.



Select mode or program







Setting / OK

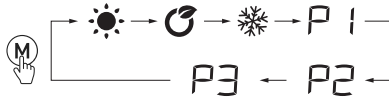

Open-window on/off







2) Quick start (basic operation):

Press  to turn on the screen, the unit will work under COMFORT mode , press   to set the desired temperature,  symbol will show when the unit is in heating mode and turn off when the set temperature is reached.





3) Clock setting:



Before setting the program, the clock will require setting before using the P1/P2/P3 programs, only when the clock is set can the programs work correctly.



Press and hold  for around 3 seconds and the clock hour setting will flash, press +/- to set the current hour (0-23), then press  once and the minute setting will flash, press +/- to set the current minutes (0-59), then press  once and the day setting will flash, press +/- to set the current day 1-7 (1 being Monday, 2 Tuesday and so on), press  to complete the time and day setting.

If you ever need to reset the time and day due to power loss or unplugging from the power source, please repeat the above instructions.

4) Functions setting explained:

1)   →  →  → P1 → P3 ← P2 → Press  to choose the mode or the program;

2) Press   to choose the temperature.

-  Comfort mode: Setting temperature from 5°C to 35°C
-  ECO mode: Setting temperature from 1.5°C to 31.5°C; which is 3.5°C less than the comfort mode.
-  Anti-Frost mode: Works on a Setting of 7°C ; Anti-Frost cannot be changed. A standard temperature of 7 – 8°C where, when activated, the unit works at this lower temperature without increasing consumption to prevent freezing.

5) Screen Child Safety lock

Please note, during any programming, if the unit controls are not used for 1 minute, the unit display will dim and go into child lock mode. To unlock simply follow the instruction below.

Press  together to unlock the control panel.

6) Program Settings

The unit has three programs which can be modified according to your requirements.

P1 This Program is preset Monday to Sunday and operates the same time and mode you set Monday to Sunday.

P2 This Program is preset Monday to Friday and Saturday to Sunday and operates the same time and mode you set for Monday to Friday and Saturday to Sunday.

P3 This program lets you set each day individually to your set time and mode requirements Monday to Sunday and is usually the preferred program.

The following pages follow you through the steps on how to program each program individually. Please take time to practice and learn how to program the units. If at any time you need assistance, please call our dedicated Help Desk on 0800 091 3171 or email: sales@hygienesuppliesdirect.com who will only be too happy to help.

7) Screen Child Safety lock







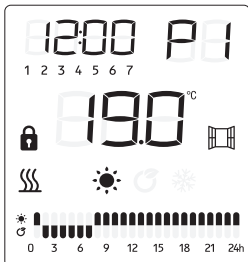

Please note, during any programming, if the unit controls are not used for 1 minute, the unit display will dim and go into child lock mode. To unlock simply follow the instruction below.

Press  together to unlock the control panel.

Setting Program P1: This program operates the same time and mode you preset from Monday to Sunday.



Example: Monday – Sunday

- Press **M** until the program **P1** is displayed, then press  once to modify the program.
- **P1** and the first hour bar and modes   start to flash.
- Press **M** to choose the mode you require for this hour either ,  or .
- Once the mode is selected press  to move to the next hour or  if you wish to move back to the previous hour to change your mode.
- Repeat this process for every hour choosing your required mode for each hour until you have set 24 hours. Then press  to confirm your 24 hour settings.
- The unit is now set for **P1**, the current hour will flash showing and also show the mode symbol set for that hour.
- **P1** will now operate to your set time and mode the same each day Monday-Sunday. The unit memory will remember your settings for this program unless the unit is switched off from the power source for a period of time.

Setting Program P2 : This program operates the same set time and mode you set from Monday to Friday and same program from Saturday to Sunday.

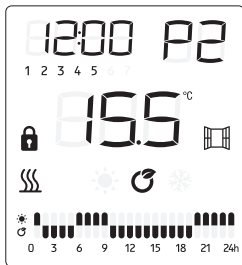



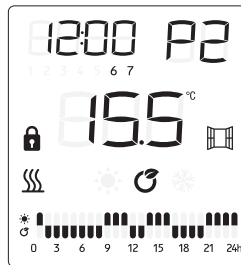

Example: Monday to Friday



Example: Saturday to Sunday

- Press **M** until the program **P2** is displayed, then press  once to modify the program.

- P2 and the first hour bar and modes 0 start to flash and days 1 2 3 4 5 are displayed.
- Press (M) to choose the mode you require for this hour either ,  or .
- Once the mode is selected press the (+) to move to the next hour or (-) if you wish to move back to the previous hour. Repeat this process for every hour choosing your required mode for each hour until you have set 24 hours.
- Then press  to confirm your 24 hour settings, the unit is now set for P2 for Monday-Friday 1 2 3 4 5.
- 6 7 now displays for days Saturday-Sunday and can be set by repeating the above process and choosing the mode for each hour up to 24 hours.
- One set then press  to confirm your 24 hour settings, the unit is now set for P2 for Saturday - Sunday 6 7.
- The unit is now set for P2 and the current hour will flash showing the mode symbol set for that hour.
- P2 will now operate your set time each day Monday-Friday and Saturday-Sunday. The unit memory will remember your settings for this program unless the unit is switched off from the power source for a period of time.

Need assistance please call our dedicated Help Desk on 0800 091 3171 or email: sales@hygienesuppliesdirect.com who will only be too happy to help.



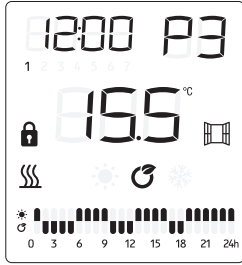

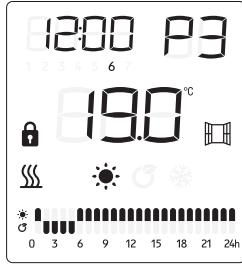

Setting program **P3** This program lets you set the time and mode for each individual day Monday – Sunday and is usually the user preferred program.



Monday





Saturday

- Press **(M)** until the program **P3** is displayed, then press **(⚙️)** once to modify the program.
- **P3** and the first hour bar and modes    start to flash.
- Press **(M)** to choose the mode you require for this hour either ,  or .
- Once the mode is selected press the **(+)** to move to the next hour or **(-)** if you wish to move back to the previous hour.
- Repeat this process for every hour, choosing your required mode for each hour until you have set 24 hours. Then press **(⚙️)** to confirm your 24 hour settings for this day. The display will then move to day 2 (Tuesday).
- Tuesday is now ready to set to your requirements, repeat the above process until all days 1-7 are set to your requirements.
- Once day 7 (Sunday) is set press **(⚙️)** to confirm and the unit display will revert to the current day, hour and mode and continue to work to your set requirements. The unit memory will remember your settings for this program, unless the unit is switched off from the power source for a period of time.

Need assistance please call our dedicated Help Desk on 0800 091 3171 or email: sales@hygienesuppliesdirect.com who will only be too happy to help.

8) Open Window Detection Function:

Press  to turn on/off the windows function. When the logo displays on the screen, it means window function is active.

When the function is active, a drop in temperature by 2°C in less than 2 minutes means the heater detects a open window and will stop working and the window logo  will flash. This is an energy saving function.

Press  and the heater will go back to former running program and the windows logo will stop flashing.

9) Screen Child Safety lock

Please note, during any programming, if the unit controls are not used for 1 minute, the unit display will dim and go into child lock mode. To unlock simply follow the instruction below.

Press  together to unlock the control panel.

MAINTENANCE

1. Always disconnect the appliance and let it completely cool before any maintenance.
2. Use a vacuum cleaner to remove dust on grilles.
3. Clean the outside of the unit with a damp cloth and then dry it with a dry cloth. Never immerse the unit in water, nor let water drip into the unit.

STORING

1. Always disconnect the appliance, let it completely cool and clean it before storing.
2. If you do not use the device for a long period, put back the unit and the instruction manual to the original carton and store in a dry and ventilated place.
3. Do not place any heavy items on top of carton during storing, as this may damage the appliance.



This marking indicates that this product should not be disposed of with other household wastes throughout the EU. To prevent possible harm to the environment or human health from uncontrolled waste disposal, recycle it responsibly to promote the sustainable reuse of material resources. To return your used device, please use the return and collection systems or contact the retailer where the product was purchased. They can take this product for environmental safe recycling.

Information requirements for electric local space heaters

Model identifier(s): MYHH0406C					
Item	Symbol	Value	Unit	Item	Unit
Heat output				Type of heat input, for electric storage local space heaters only (select one)	
Nominal heat output	P_{nom}	0.60	kW	Manual heat charge control, with integrated thermostat	[no]
Minimum heat output (indicative)	P_{min}	0.60	kW	Manual heat charge control with room and/or outdoor temperature feedback	[no]
Maximum continuous heat output	$P_{max,c}$	0.60	kW	Electronic heat charge control with room and/or outdoor temperature feedback	[no]
Auxiliary electricity consumption				Fan assisted heat output	
At nominal heat output	$e_{l,max}$	N/A	kW	Type of heat output/room temperature control (select one)	
At minimum heat output	$e_{l,min}$	N/A	kW	Single stage heat output and no room temperature control	[no]
In standby mode	$e_{l,sb}$	0.00014	kW	Two or more manual stages, no room temperature control	[no]
Model identifier(s): MYHH0410C				With mechanic thermostat room temperature control	
Item	Symbol	Value	Unit	With electronic room temperature control	[no]
Heat output				Electronic room temperature control plus day timer	[no]
Nominal heat output	P_{nom}	1.00	kW	Electronic room temperature control plus week timer	[yes]
Minimum heat output (indicative)	P_{min}	1.00	kW	Other control options (multiple selections possible)	
Maximum continuous heat output	$P_{max,c}$	1.00	kW	Room temperature control, with presence detection	[no]
Auxiliary electricity consumption				Room temperature control, with open window detection	[yes]
At nominal heat output	$e_{l,max}$	N/A	kW	With distance control option	[no]
At minimum heat output	$e_{l,min}$	N/A	kW	With adaptive start control	[no]
In standby mode	$e_{l,sb}$	0.00014	kW	With working time limitation	[yes]
				With black bulb sensor	[no]
Contact details	Contact details: Hygiene Supplies Direct Limited, Ground floor, Tayson House, Methley Road, Castleford WF10 1PA				

Information requirements for electric local space heaters

Model identifier(s): MYHH0415C					
Item	Symbol	Value	Unit	Item	Unit
Heat output				Type of heat input, for electric storage local space heaters only (select one)	
Nominal heat output	P _{nom}	1.50	kW	Manual heat charge control, with integrated thermostat	[no]
Minimum heat output (indicative)	P _{min}	1.50	kW	Manual heat charge control with room and/or outdoor temperature feedback	[no]
Maximum continuous heat output	P _{max,c}	1.50	kW	Electronic heat charge control with room and/or outdoor temperature feedback	[no]
Auxiliary electricity consumption				Fan assisted heat output	
At nominal heat output	e _{lmax}	N/A	kW	Type of heat output/room temperature control (select one)	
At minimum heat output	e _{lmin}	N/A	kW	Single stage heat output and no room temperature control	[no]
In standby mode	e _{lsb}	0.00014	kW	Two or more manual stages, no room temperature control	[no]
Model identifier(s): MYHH0420C				With mechanic thermostat room temperature control	
Item	Symbol	Value	Unit	With electronic room temperature control	[no]
Heat output				Electronic room temperature control plus day timer	[no]
Nominal heat output	P _{nom}	2.00	kW	Electronic room temperature control plus week timer	[yes]
Minimum heat output (indicative)	P _{min}	2.00	kW	Other control options (multiple selections possible)	
Maximum continuous heat output	P _{max,c}	2.00	kW	Room temperature control, with presence detection	[no]
Auxiliary electricity consumption				Room temperature control, with open window detection	[yes]
At nominal heat output	e _{lmax}	N/A	kW	With distance control option	[no]
At minimum heat output	e _{lmin}	N/A	kW	With adaptive start control	[no]
In standby mode	e _{lsb}	0.00014	kW	With working time limitation	[yes]
				With black bulb sensor	[no]
Contact details	Contact details: Hygiene Supplies Direct Limited, Ground floor, Tayson House, Methley Road, Castleford WF10 1PA				

SERVICE WARRANTY

Hygiene Supplies Direct guarantees the product free from defects in materials and workmanship for a period of 1 year from date of purchase. Should this unit be operated under conditions other than those recommended, at voltages other than the voltage indicated on the unit, or any attempts made to service or modify the unit, then the warranty will be rendered void. The product you buy may sometimes differ slightly from illustrations. This warranty is in addition to, and does not affect, your statutory rights. If you have any problems with this product, please call our Help Desk on 0800 091 3171 or email: sales@hygienesuppliesdirect.com